

# KA1110 16" MANHOLE ASSEMBLY

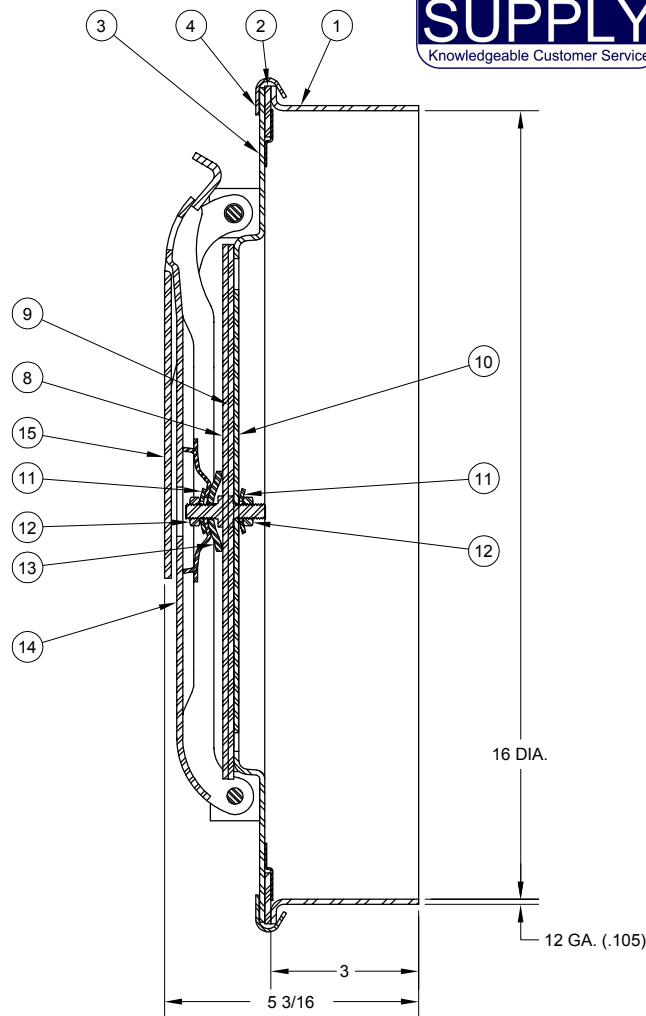
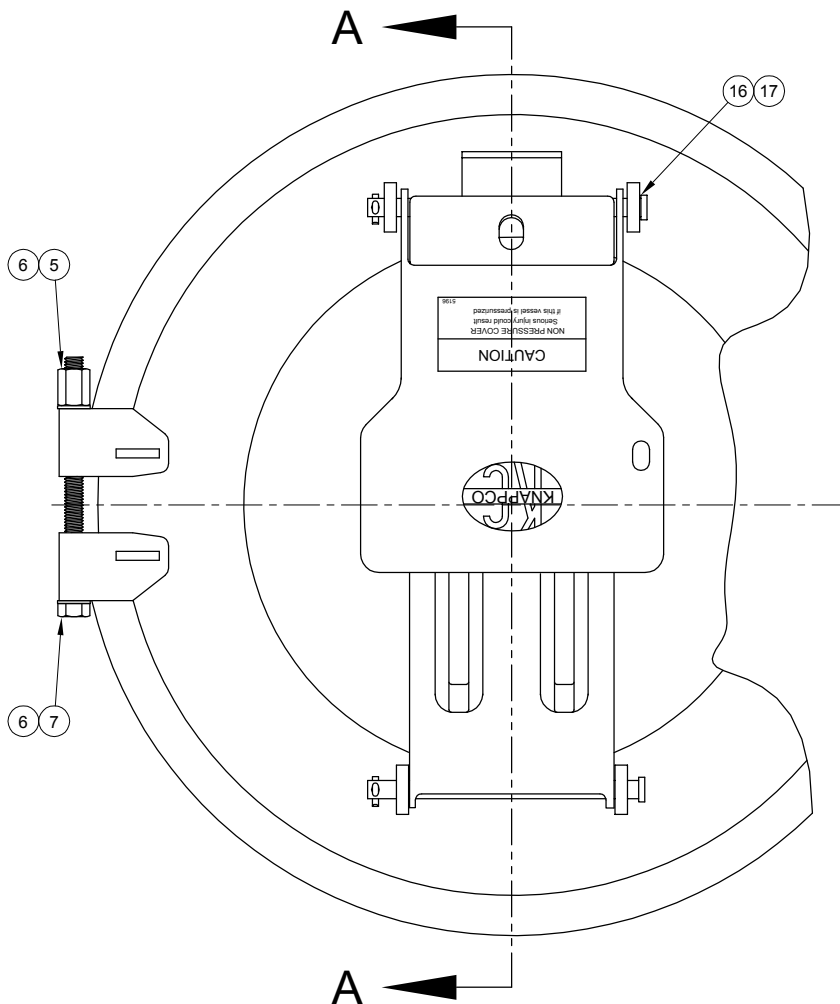

SECTION A-A

ITEM	PART NUMBER	DESCRIPTION	QTY.
1	1089	WELD RING (STEEL)	1
2	1106	GASKET (BUNA)	1
3	1119	COVER WELDMENT (STEEL)	1
4	1107	CLAMP RING ASSY. (STEEL)	1
5	5009	HEX NUT (BRASS)	1
6	1113	WASHER (PLATED)	2
7	1110	HEX CAP SCREW (PLATED)	1
8	1150	FILL COVER WELDMENT (STL)	1
9	2561	FILL COVER GASKET (BUNA)	1
10	1154	GASKET RETAINER (STL)	1
11	1117	WASHER (PLD)	2
12	1104	LOCK NUT (PLD)	2

ITEM	PART NUMBER	DESCRIPTION	QTY.
13	1101	WASHER (PLD)	1
14	3377	STRONGBACK WELDMENT (STL)	1
15	1125	LATCH (STL)	1
16	2106	CLEVIS PIN (PLD)	2
17	1045	COTTER PIN (PLD)	2

ALTERNATE SEALING MEDIA

PART NUMBER	DESCRIPTION
2701	GASKET (VITON, WELD RING)
2181	GASKET (VITON, FILL COVER)
2563	GASKET (EPDM, WELD RING)
2562	GASKET (EPDM, FILL COVER)

